

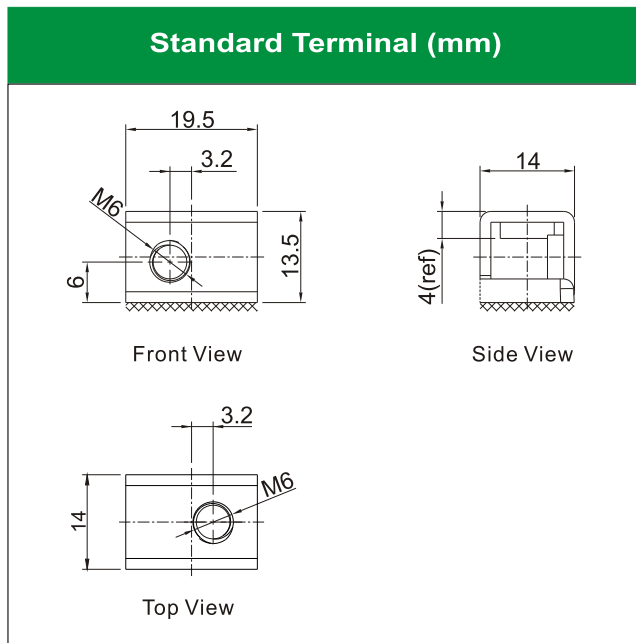

# MX16-4 [12V19Ah]

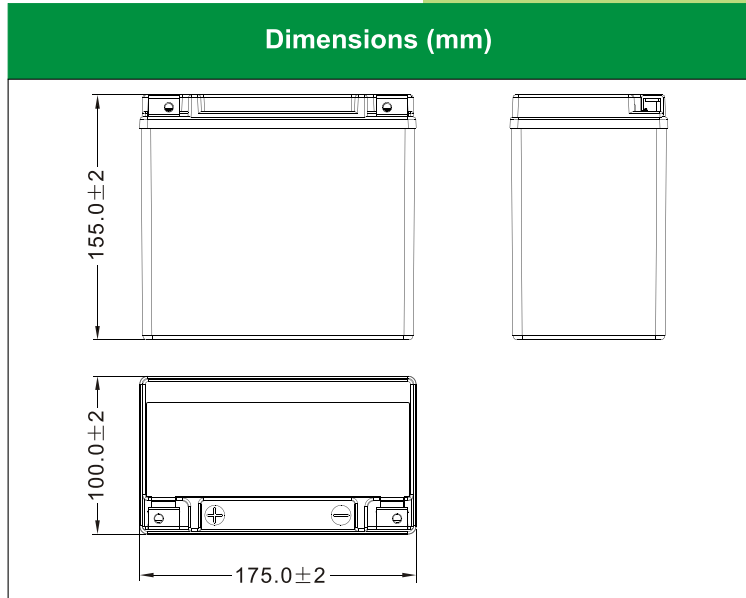

### Physical Specification

Nominal Voltage	12V	
Nominal Capacity (10HR)	19AH	
Dimension	Length	175 ± 2mm (6.89 inches)
	Width	100 ± 2mm (3.94 inches)
	Container Height	155 ± 2mm (6.10 inches)
	Total Height (with Terminal)	155 ± 2mm (6.10 inches)
Weight	Battery(with acid): Approx 7.15kg (15.77lbs)	
	Electrolyte: Approx 1.3kg (2.87lbs)	

- \* Sealed and non-spillable AGM battery
- \* Maintenance-free
- \* Powerful 350 cold cranking amps
- \* Shipped pre-charged and ready to install

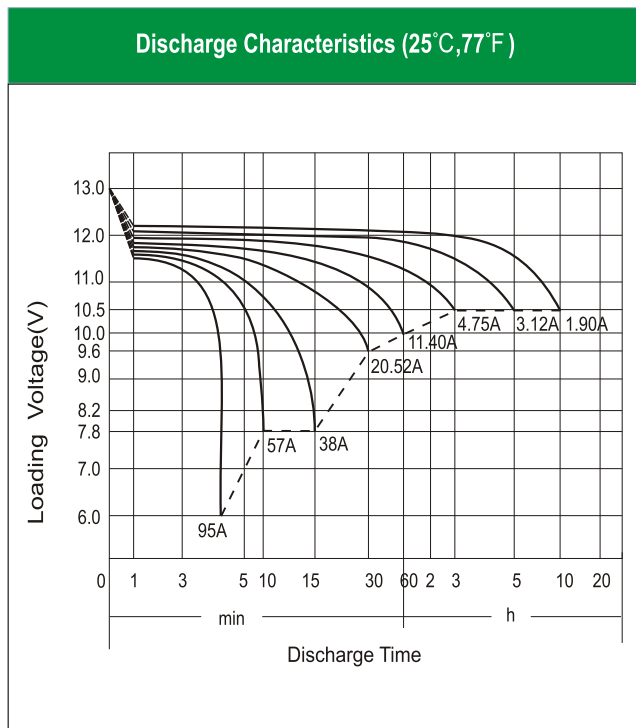

### Electrical Specification

Rated Capacity	10 hour rate (1.90 A)	19.00AH
	5 hour rate (3.12 A)	15.58AH
	2 hour rate (6.65 A)	13.30AH
	1 hour rate (11.40 A)	11.40AH
	0.5 hour rate (20.52 A)	10.26AH
Capacity affected by Temperature	40 °C (104 °F)	106%
	25 °C (77 °F)	100%
	0 °C (32 °F)	86%
	-15 °C (5 °F)	65%
Self Discharge	Approximately 3% per month (25°C (77°F))	
Charging Methods	Full Charge	Constant-Voltage Charge: Initial charging current: less than 5.7A Voltage: 14.40 V ~ 15.00 V at 25 °C (77 °F) Charging time: 15 ~18h Constant-Current Charge: Charging current: 0.1C <sub>10</sub> =1.90A, when charging voltage up to 14.40V, continue to charge 4h
	Floating Charge	No limit on Initial charging current Voltage: 13.50 V ~ 13.80 V at 25 °C (77 °F)