

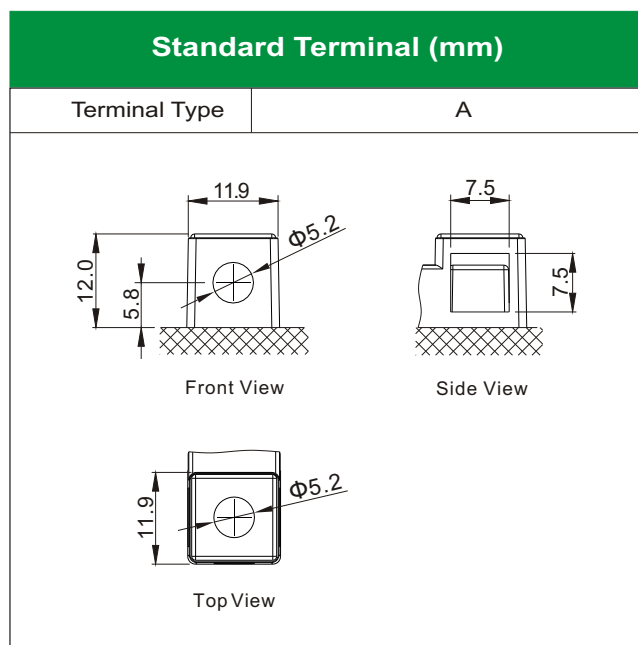

# EB12B-BS(U) [12V10Ah]

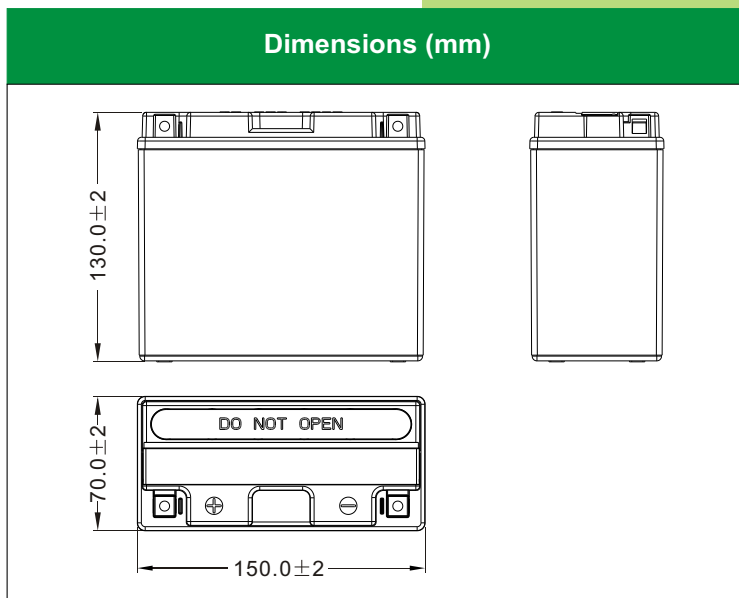

### Physical Specification

Nominal Voltage	12V	
Nominal Capacity (10HR)	10AH	
Dimension	Length	150 ± 2mm (5.91 inches)
	Width	70 ± 2mm (2.76 inches)
	Container Height	130 ± 2mm (5.12 inches)
	Total Height (with Terminal)	130 ± 2mm (5.12 inches)
Weight	Battery(with acid): Approx 3.39kg (7.47lbs)	
	Electrolyte: Approx 0.67kg (1.48lbs)	

- \* Sealed AGM battery
- \* Fresh Pack, Maintenance Free
- \* Powerful 120 cold cranking amps
- \* Rest after filling acid
- \* Maximum tilt angle for installation: 25°

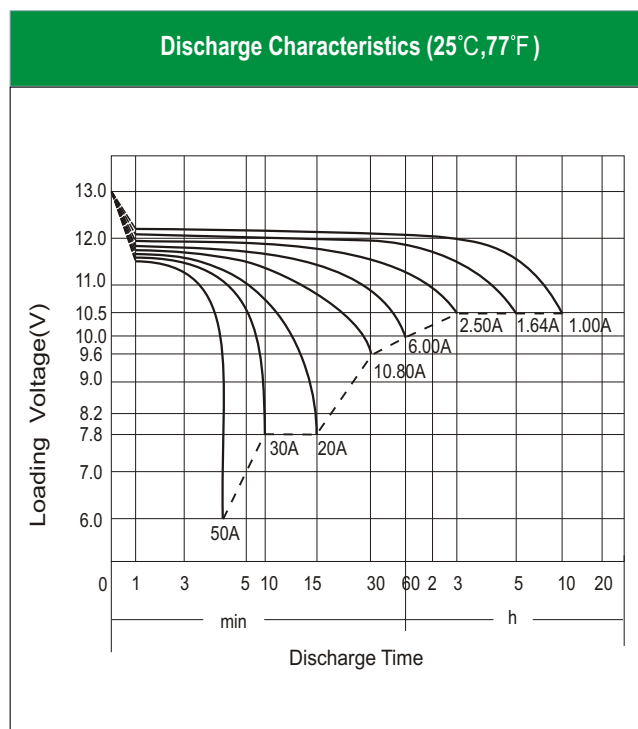

### Electrical Specification

Rated Capacity	10 hour rate (1.00 A)	10.0AH
	5 hour rate ( 1.64 A)	8.20AH
	2 hour rate (3.50 A)	7.00AH
	1 hour rate (6.00 A)	6.00AH
	0.5 hour rate (10.80 A)	5.40AH
Capacity affected by Temperature	40 C (104 F)	106%
	25 C (77 F)	100%
	0 C (32 F)	86%
	-15 C (5 F)	65%
Self Discharge	Approximately 3% per month (25C (77F ))	
Charging Methods	Full Charge	Constant-Voltage Charge: Initial charging current: less than 3.0A Voltage: 14.40 V ~ 15.00 V at 25 °C (77 °F) Charging time: 15 ~18h Constant-Current Charge: Charging current: 0.1C <sub>10</sub> =1.00A, when charging voltage up to 14.40V, continue to charge 4h
	Floating Charge	No limit on Initial charging current Voltage: 13.50 V ~ 13.80 V at 25 °C (77 °F)