

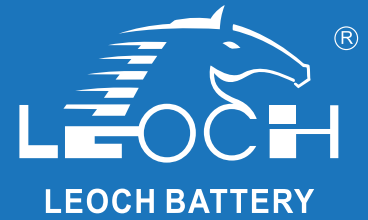

LPCG Series-Deep Cycle Gel

LPCG12-90(12V90Ah)



Specifications

Rated Voltage	12V	
Nominal Capacity	90Ah (C ₂₀ , 1.80V/cell)	
Dimension	Length	306±2mm (12.0 inches)
	Width	168±2mm (6.61 inches)
	Container Height	208±2mm (8.19 inches)
	Total Height	214±2mm (8.43 inches)
Approx Weight	26.5 Kg (58.4lbs)	
Terminal	M6	
Container Material	ABS	
Rated Capacity (25°C)	90.0 Ah	(20hr, 4.50A, 1.80V/cell)
	85.0 Ah	(10hr, 8.50A, 1.80V/cell)
	75.0 Ah	(5hr, 15.0A, 1.75V/cell)
	67.2 Ah	(3hr, 22.4A, 1.75V/cell)
	52.1 Ah	(1hr, 52.1A, 1.67V/cell)
Max. Discharge Current	850A (5s)	
Internal Resistance (25°C)	Approx 7.40mΩ	
Operating Temp. Range	Discharge	-20 ~ 55°C (-4 ~ 131°F)
	Charge	0 ~ 40°C (32 ~ 104°F)
	Storage	-20 ~ 50°C (-4 ~ 122°F)
Nominal Operating Temp. Range	25±3°C (77±5°F)	
Cycle Use	Initial Charging Current less than 21,3A. Voltage 14.4V~14.7V at 25°C(77°F)Temp. Coefficient -30mV/°C	
Standby Use	Initial Charging Current less than 21,3A. Voltage 13.5V~13.8V at 25°C(77°F)Temp. Coefficient -20mV/°C	
Effect of temp. to Capacity	40°C (104°F)	103%
	25°C (77°F)	100%
	0°C (32°F)	86%
Self Discharge	LPCG series batteries may be stored for up to 9 months at 25°C(77°F) and then a freshening charge is required. For higher temperatures the time interval will be shorter.	



Layout

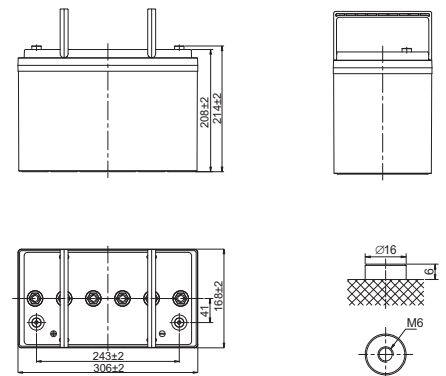

Constant Current Discharge (Amperes) at 25 °C (77°F)

F.V/Time	1h	2h	3h	4h	5h	6h	8h	10h	20h
1.85V/cell	40.0	24.7	19.6	15.9	13.9	12.1	9.83	8.33	4.30
1.80V/cell	44.2	27.2	21.5	17.3	14.6	12.8	10.3	8.50	4.50
1.75V/cell	49.6	29.2	22.4	17.9	15.0	13.2	10.4	8.76	4.64
1.67V/cell	52.1	30.3	23.1	18.2	15.5	13.5	10.6	8.84	4.74
1.60V/cell	53.8	31.0	23.4	18.5	15.8	13.7	10.7	8.93	4.80

Constant Power Discharge (Watts/cell) at 25 °C (77°F)

F.V/Time	1h	2h	3h	4h	5h	6h	8h	10h	20h
1.85V/cell	77.7	48.3	38.5	31.3	27.3	23.9	19.4	16.5	8.56
1.80V/cell	85.3	52.9	42.0	33.9	28.7	25.2	20.2	16.8	8.94
1.75V/cell	95.0	56.4	43.5	34.8	29.4	26.0	20.5	17.3	9.20
1.67V/cell	98.7	58.2	44.6	35.2	30.1	26.3	20.8	17.4	9.39
1.60V/cell	101.0	59.0	44.8	35.7	30.6	26.6	20.9	17.5	9.51

LPCG Series-Deep Cycle Gel

LPCG12-90(12V90Ah)

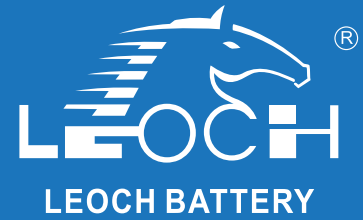

Applications

- Electrically powered wheelchair
- Vehicle in place of walking
- Lawn-mower
- Golf trolleys and golf cart
- Railway and marine systems

General Features

- Special plate design, long cycle life
- ≥ 600 Cycles @ 80%DOD
- Operation temperature $-20 \sim 55^{\circ}\text{C}$
- $\leq 2\%$ Self discharge per month
- Good deep discharge resilience performance

Standards

- IEC 60896 Certified
- Classified as "Long Life" according to Eurobat
- UL Certified
- Manufactured in Leoch® IATF16949, ISO 9001, ISO 14001 and OHSAS 18001 certified production facilities

Discharge Characteristics

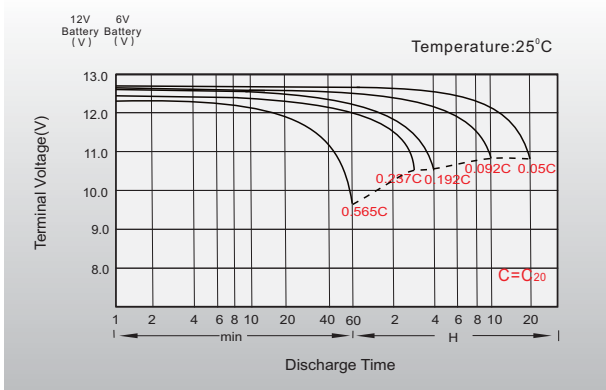

Charging Characteristics

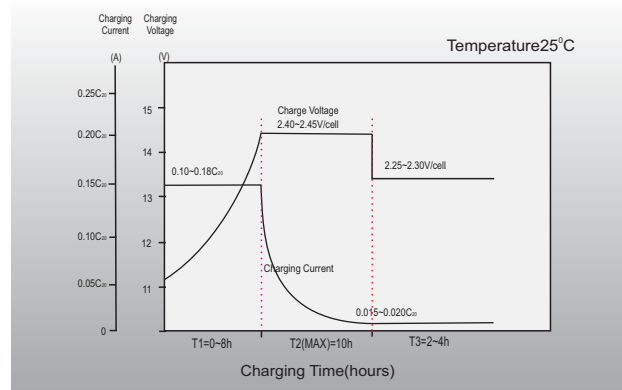

Cycle Life in Relation to Depth of Discharge

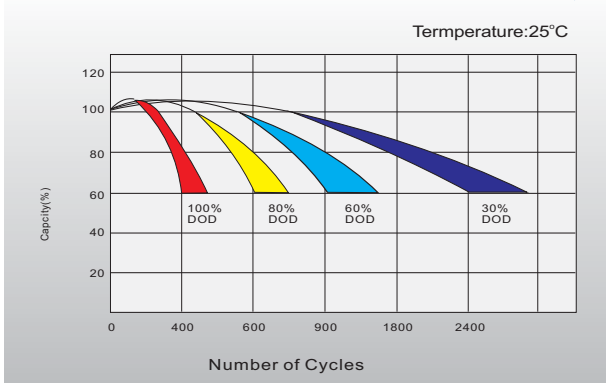

Temperature Effects in Relation to Battery Capacity

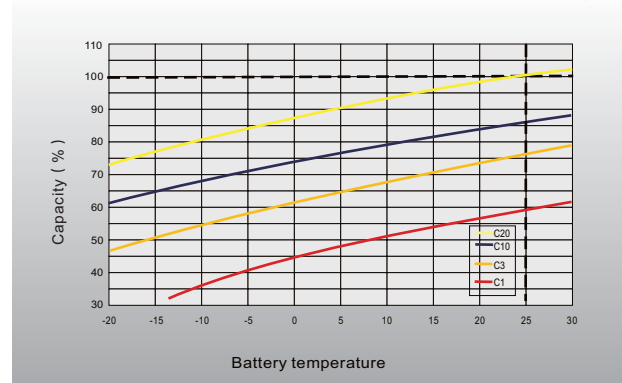

Sales Offices Worldwide

China Sales Office

5th Floor, Xinbaohui Bldg., Nanhai Blvd.,
Nanshan, Shenzhen, China. 518052
Tel: +86-755-86036060 (100 lines)
Fax: +86-755-26067269
E-mail: export@leoch.com

HongKong Sales Office

Workshop C, 33/F, TML Tower, No. 3 Hoi Shing Road,
Tsuen Wan, New Territories, Hong Kong
Tel: +852 35786666
Fax: +44 1452 690125
E-mail: sales.hk@leoch.com

Singapore Sales Office

No. 1 Tech Park Crescent,
Singapore 638131
Tel: +65 68636078
Fax: +65 6863 6079
Email: sales.sg@leoch.com

Australia Sales Office

2 /29 Tarlington Place, Smithfield. NSW 2164
Australia
Tel: 02 9756 0950
E-mail: sales.au@leoch.com

North America Sales Office

19751 Descartes
Foothill Ranch, CA 92610, USA
Tel: 949-588-5853
Fax: 949-588-5966
E-mail: sales@leoch.us

UK Sales Office

9B Wheatstone Court. Waterwells, Business Park,
Gloucester, GL2-2AQ, UK United Kingdom
Tel: +44(0) 1452 729428 / 1452 729696
Fax: +44 1452 690125
E-mail: Sales.Europe@leoch.com

EMEA Sales Office

1 Deligiorgi St., 121 31 Athens,
Greece
Tel: +30 210 5760318 (2 lines)
E-mail: support_EMEA@leoch.com

India Sales Office

Shed no.A-53(b), 2nd Stage of Peenya Industrial Area,
Bangalore North Taluk, Bangalore-560058, India
Tel: +91-80-23440018/23440019
Fax: +91-80-23440017
E-mail: indiasales@leoch.com



[Http://www.leoch.com](http://www.leoch.com)
[Http://www.leoch.us](http://www.leoch.us)

© 2019 LEOCH. All rights reserved.
Trademarks and logos are the property of LEOCH and its affiliates unless otherwise noted.
Subject to revisions without prior notice.

Publication No.:LB-LPCG12-90-PD-EN-V2.1-201912