



DEEP CYCLE AGM TECHNOLOGY

LDC12-115-G31-T BCIGROUP 31

FEATURES & BENEFITS

- True deep cycle AGM technology-GREEN SOLUTION
- Over 99.99% virgin lead for grid plate and active material
- Heavy duty grid/paste design for deep cycle application
- Maintenance free, non-spillable, valve-regulated
- Double separator configuration: long cycle life & High energy density and super anti-vibration design
- Low self-discharge for longer shelf life



ELECTRICAL SPECIFICATIONS

Voltage(V)	Capacity (AH)					Reserve Capacity (Min)		
	100HR	20HR	10HR	5HR	3HR	@25A	@56A	@75A
12	130	118	113	107	98	239	95	65

PHYSICAL SPECIFICATIONS

Model	Dimensions (mm/inches)				Weight (kg/lbs)	Terminal Type (Standard)	Case Material
	Length	Width	Height	Total Height			
LDC12-115-G31-T	330 (12.99)	173 (6.81)	212 (8.35)	220 (8.66)	31.4 (69.2)	T11	ABS

Operating Temperature Range		
Discharge	Charge	Storage
-15°C ~ 50°C (5°F ~ 122°F)	0°C ~ 40°C (32°F ~ 104°F)	-15°C ~ 40°C (5°F ~ 104°F)

LDC12-115-G31-T

DIMENSIONS

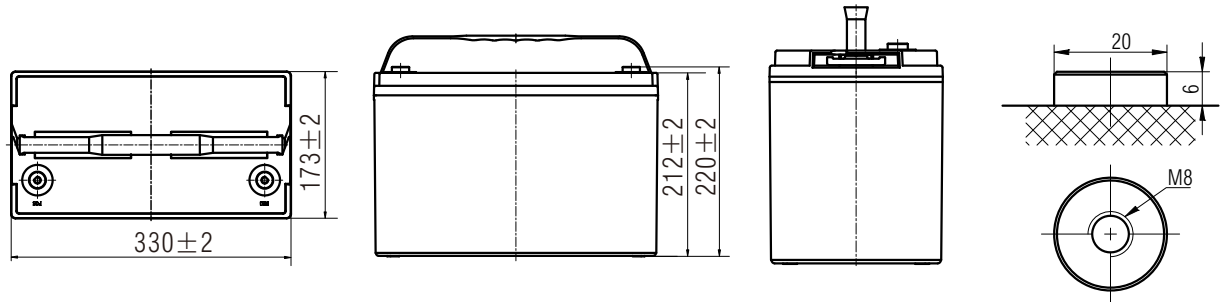

Note: Terminal Torque Values in-lb(Nm) : 97.28-130.0(11-14.7)

PERFORMANCE CHARACTERISTICS

LEOCH LDC AGM Charging Profile

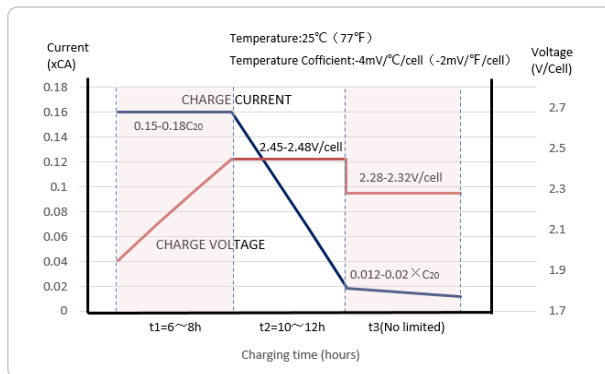

Relationship of OCV and State Of Charge (25°C, 77°F)

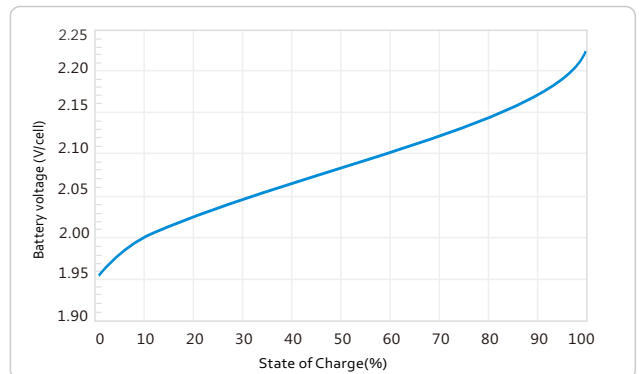

Cycle life in relation to Depth Of Discharge

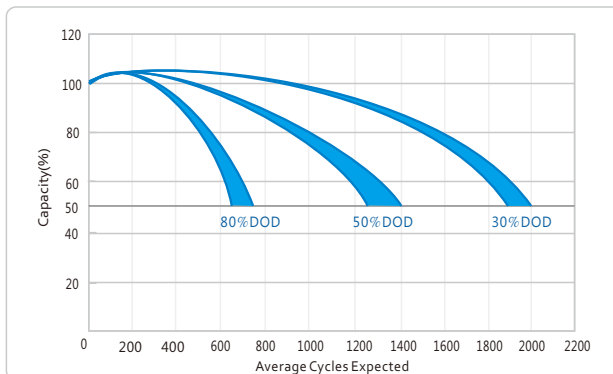

Self-discharge Characteristic

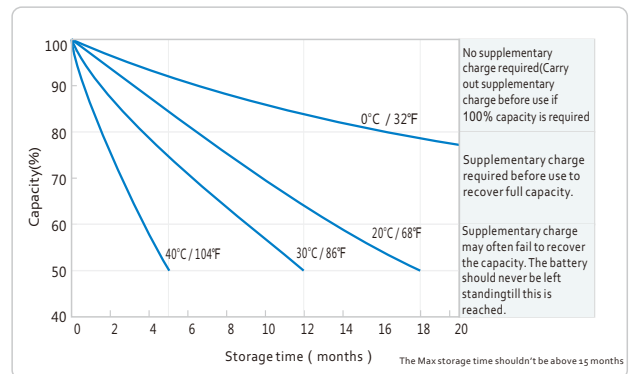

- LEOCH INTERNATIONAL SALES OFFICE:
Add: 5th Floor, Xinbaohui Bldg.
Nanhai Blvd, Nanshan, Shenzhen, China. 518054
Tel: +86-755-86036060(100 lines) Fax: +86-755-26067269
E-mail: export@leoch.com
web: www.leoch.com