

FT410L



CYCLING CAPACITY

20 Hour Rate **28 Amp Hours**

RESERVE CAPACITY

Reserve @25 AMPS **48 Minutes** Reserve @75 AMPS **10.1 Minutes**

ELECTRICAL SPECIFICATIONS

Nominal Voltage	12 Volt
C100	31 AH
C20	28 AH
C5	23 AH
Short Circuit Current	1382 Amps
CCA	410 Amps
CA or MCA	530 Amps
PHCA	925 Amps
Internal Resistance	6.6 mΩ

MECHANICAL SPECIFICATIONS

Group Size	-	
Terminal Type	M6 + TP26 (SAE)	
Terminal Torque	See reverse side	
Height (w/ terminal)	5.64"	144 mm
Height (case only)	4.92"	125 mm
Width	6.93"	176 mm
Length	6.50"	165 mm
Weight	23.6 lbs	10.7 kg
Case Type	ABS Plastic - Flame Res. Rating UL94-HB	

DISCHARGE TABLE (Constant Current)

Time	Amps	Rate
20hr	1.4	0.05 CA
10hr	2.5	0.10 CA
8hr	3.0	0.13 CA
5hr	4.6	0.25 CA
3hr	7.0	0.33 CA
2hr	9.4	0.50 CA
1hr	16.8	1.00 CA

DISCHARGE PROFILE (Constant Current)

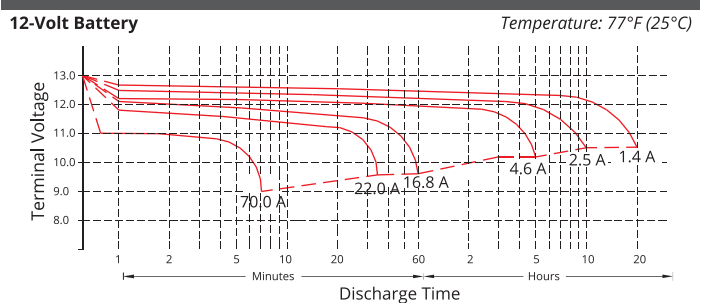

- All listed ratings are @ 100% SoC, T=77°F (25°C), 1.75VPC unless otherwise specified.
 - Specifications listed are for estimation purposes only. Battery performance can vary depending on application. Battery design subject to change.

BATTERY & TERMINAL DIMENSIONS (All units shown in mm)

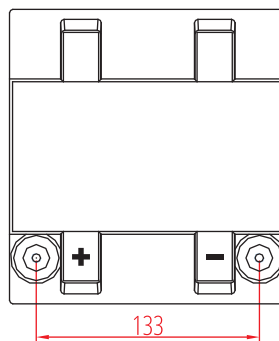
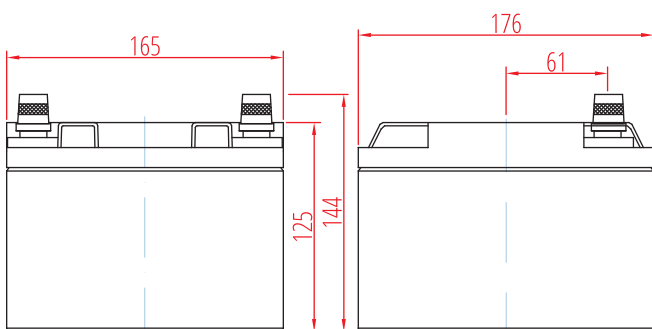

Terminal: M6 + TP26

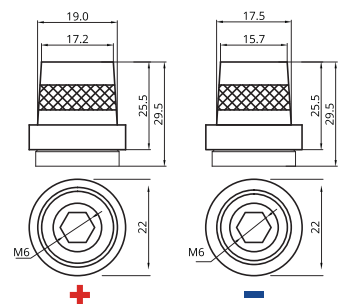

FULL THROTTLE SERIES | HIGH CRANKING AGM

fullriverbattery.com

TEMPERATURE vs CAPACITY

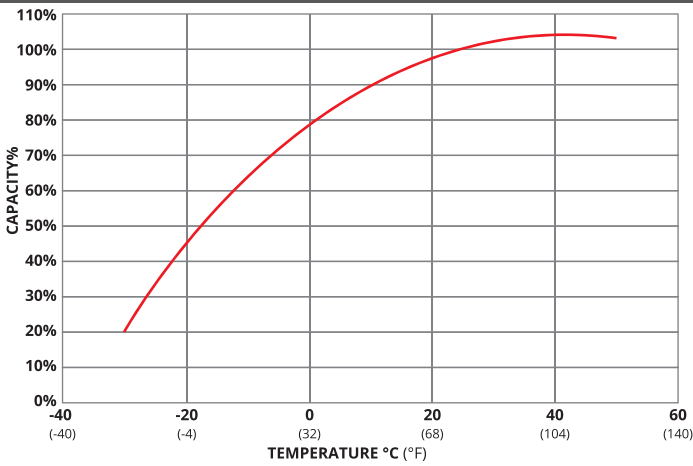

STATE of CHARGE (SOC) vs OPEN CIRCUIT VOLTAGE (OCV)

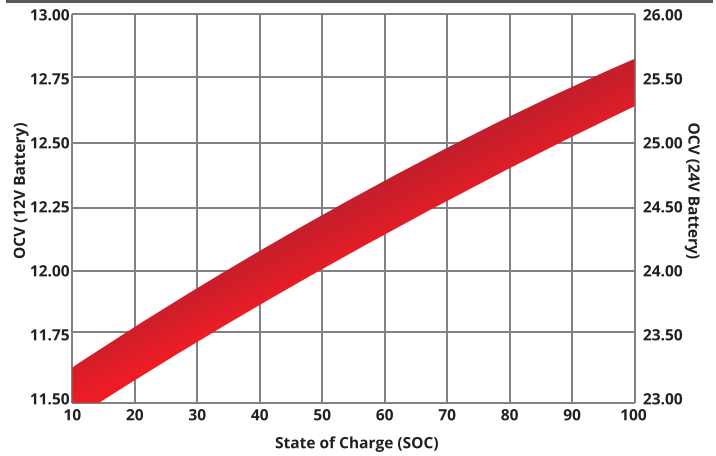

CYCLE LIFE vs DEPTH of DISCHARGE (DOD)

*(Based on BCI Testing @ 2-hr Rate)

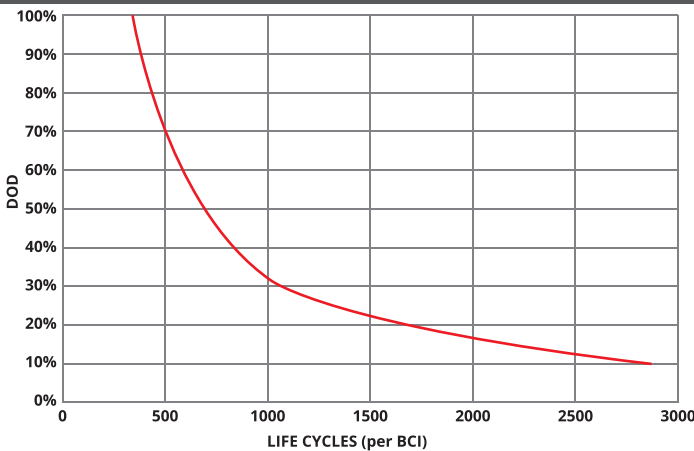

SELF DISCHARGE vs TIME/TEMPERATURE

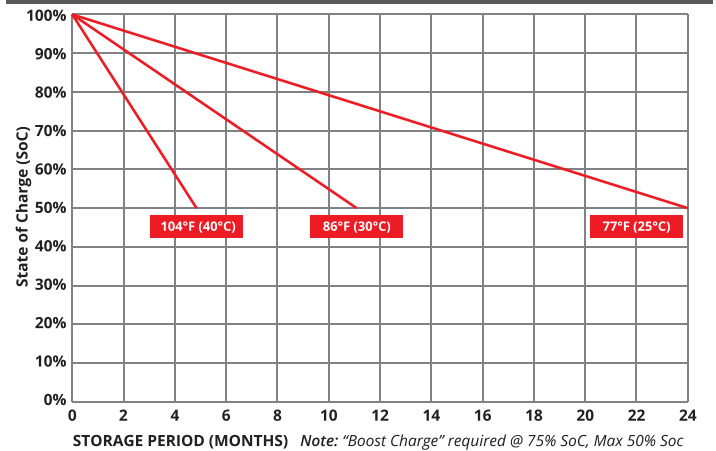

TEMPERATURE RANGE SPECIFICATIONS

Condition	Recommended	Maximum	Recommended	Maximum
Storage	5°F to 122°F	-40°F to 160°F	-15°C to 50°C	-40°C to 71°C
Operation	5°F to 104°F	-40°F to 160°F	-15°C to 40°C	-40°C to 71°C
Charge with TC	5°F to 122°F	-40°F to 160°F	-15°C to 50°C	-40°C to 71°C
Charge w/o TC	32°F to 104°F	5°F to 122°F	0°C to 40°C	-15°C to 50°C

*TC= Temperature Compensation

CHARGE VOLTAGES

Charge Stage	Battery Voltages			
	12V	24V	36V	48V
Bulk	14.4 - 14.7V	28.8 - 29.4V	43.4 - 44.1V	57.6 - 58.8V
Absorption	14.4 - 14.7V	28.8 - 29.4V	43.4 - 44.1V	57.6 - 58.8V
Float	13.6V	27.2V	40.8V	54.6V

TC Factor: (-2mV°F/cell) or (-4mV°C/cell)

TERMINAL TORQUE SPECS

Terminal Type	ft-lbs	in-lbs	Nm
AP, DT (AP), M6, M6M (Stud), TP07 (AP), TP08 (AP)	4.2 - 6.0	50-70	5.6 - 7.9
FR45	6.0 - 7.5	70-90	7.9 - 10.1
M8	7.1 - 8.0	85-95	9.6 - 10.7
DT (Stud), M10M (Stud)	9.2 - 10.4	110-125	12.2 - 14



9001:2008 Quality Management System
 14001:2004 Environmental Management System
 18001:2007 Occupational Health & Safety Management System



TPPL TECHNOLOGY

DELIVERY APPROVED!
**LAND, SEA
 & AIR**

Fullriver batteries are sealed lead acid batteries made with Absorbed Glass Mat (AGM) technology. The electrolyte is absorbed into the fiberglass separator material rather than in a free-flowing liquid form. Fullriver batteries are non-spillable electric storage batteries. They are exempted from the requirements of DOT's hazardous materials regulations, since they adhere to the requirements of code 49 CFR Section 173.159(D) - (CLASSIFIED APPROVED: DOT, CFR, HMR49, IATA, ICAO67, IMDG27)